

Installation Manual-BV A01124

MOTIVATE
YOUR LIFE !

THANKS FOR WATCHING

Your feedback is invaluable to us and we would love to hear about your experience. Please take the time to leave us a review.

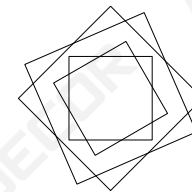
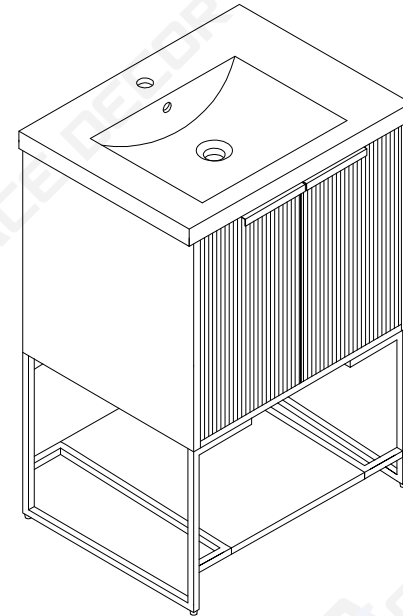



Thank you for shopping with us!

We encourage you to take a few minutes to go through this booklet. It contains important information on installation and care tips to keep your furniture looking as good as new.

Item NO.:BV A01124

Hardware

NO.	Description	QTY
A	M4X12  Screws M4x12mm	12
B	 Expansion Bolts	2
C	 Screws for fix on the wall M5.5x60	2

Tools

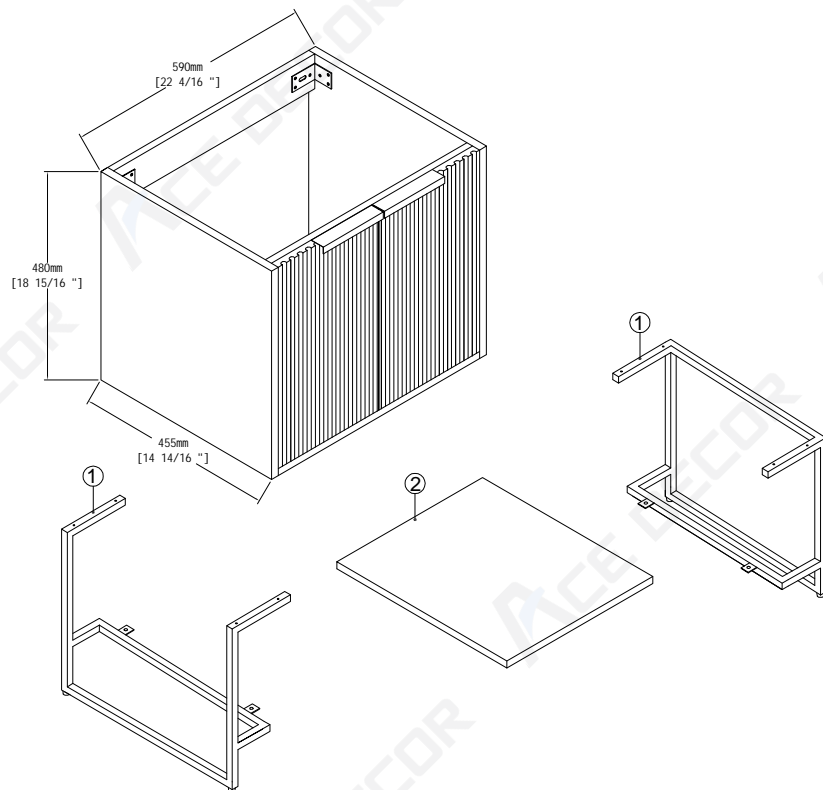

Dimensions

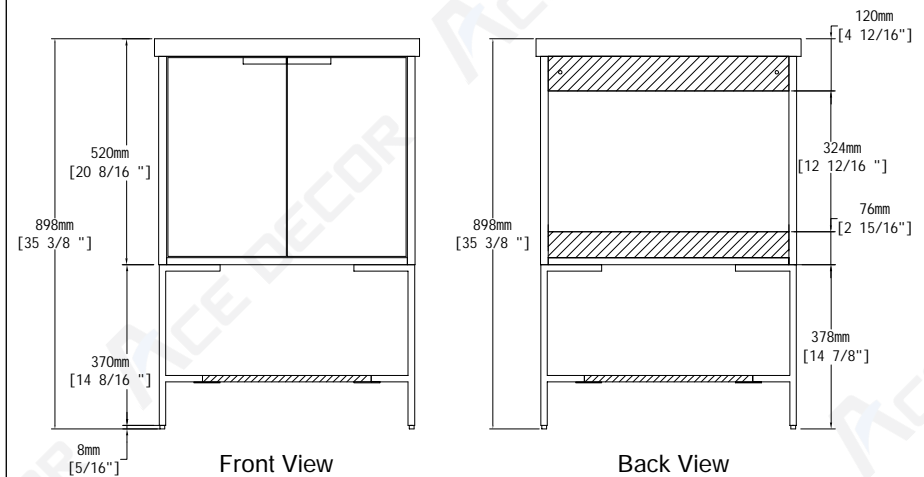

CARE CLEANING AND MAINTENANCE

1. Dust regularly with a soft , dry cloth.
2. Avoid the use of all chemicals household cleaners, abrasives, or cleaners that contain lemon, vinegar, or other acids that may damage the finish.
3. Excessive exposure to sunlight and extreme changes in temperature and moisture can damage wood furniture.
4. The sink top is resilient, but care needs to be taken to preserve its appearance.
5. Do not place hot appliances, such as curling irons and hot hair dryers directly on the countertop. Wipe spills immediately.

Step 5

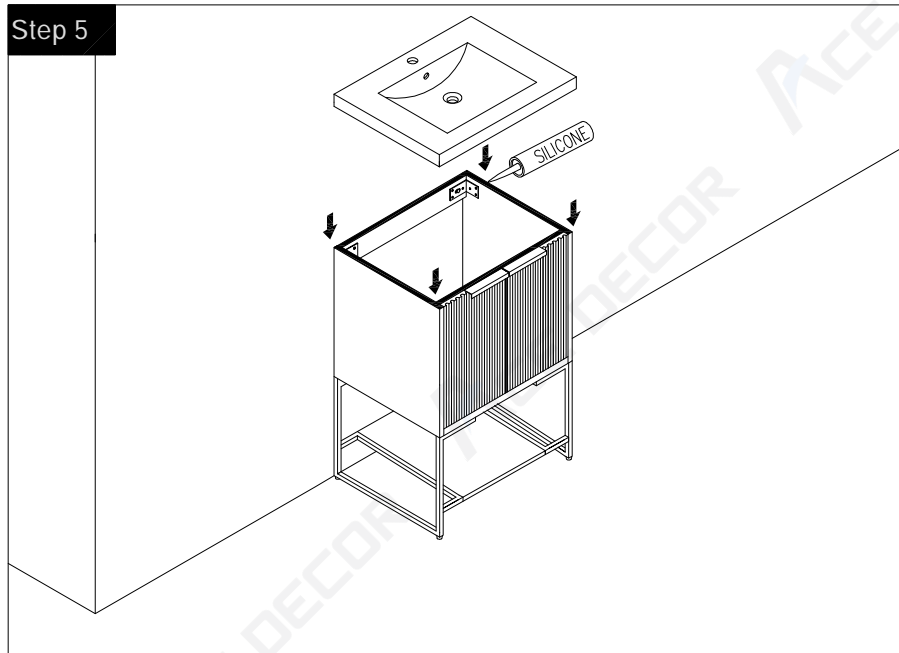

Finished

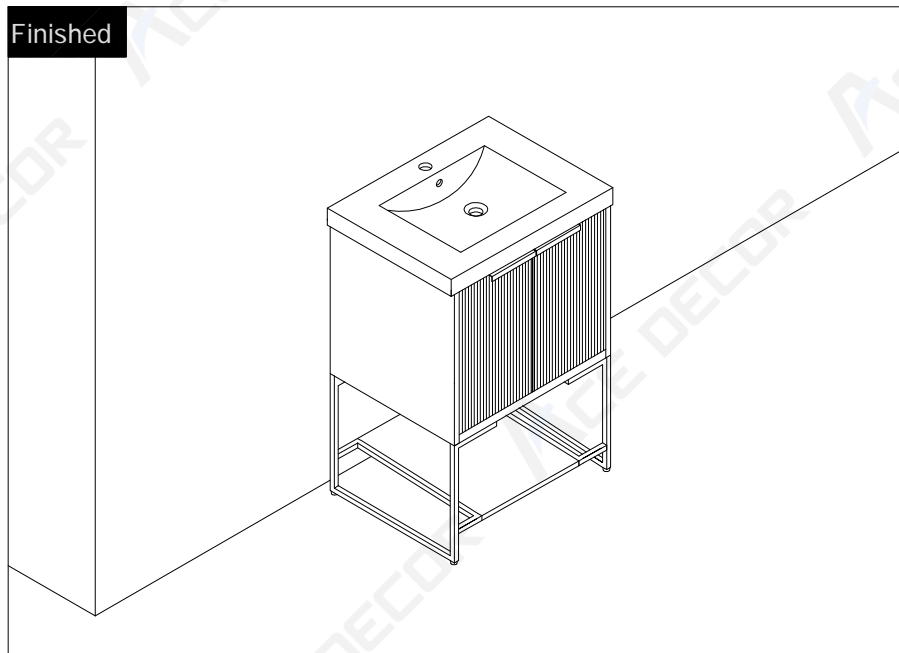

Step 1

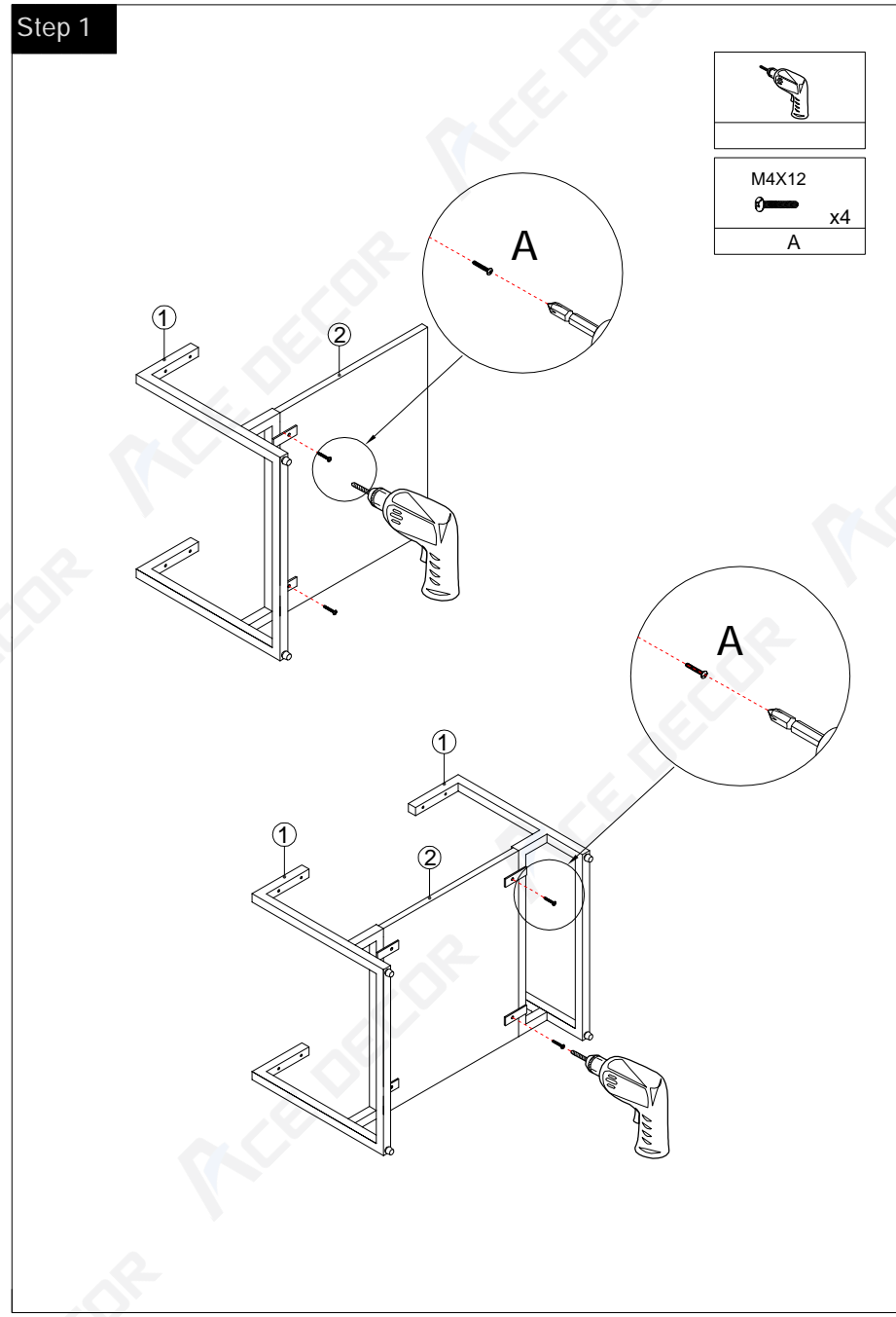

Step 2

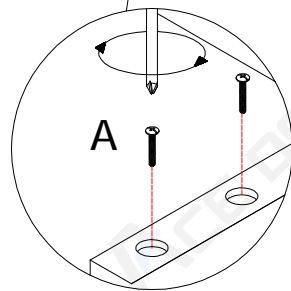
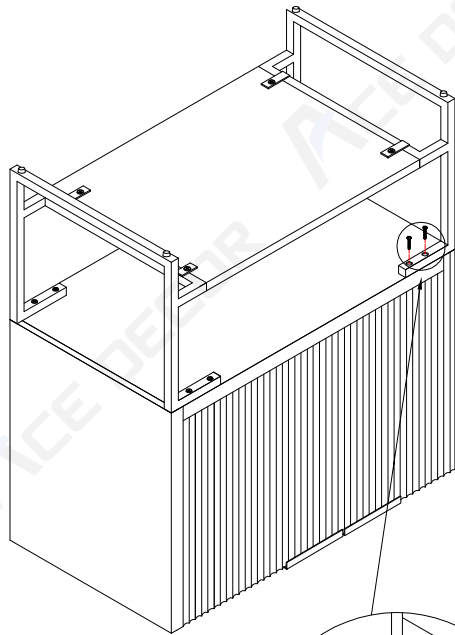
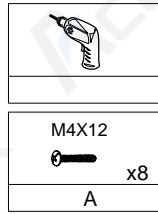

Step 3

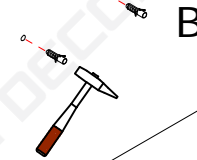
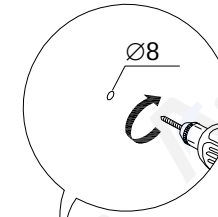

Step 4

